

## Data sheet | Item number: 890-606

T-distribution connector; 3-pole; Cod. A; 1 input; 2 outputs; 2 locking levers;  
black

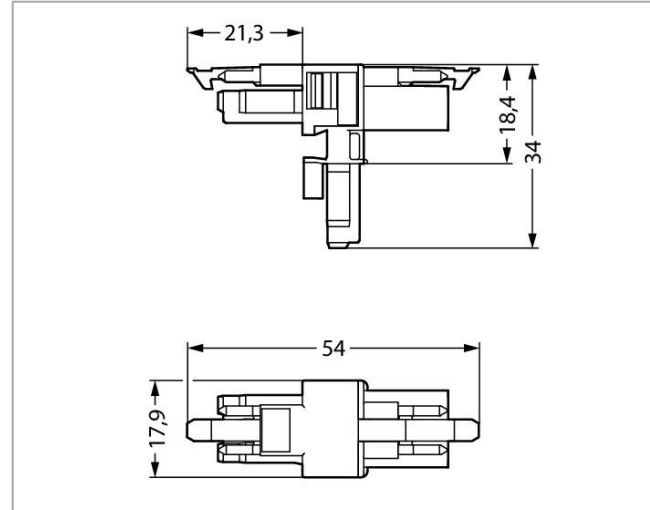

[www.wago.com/890-606](http://www.wago.com/890-606)



### Item description

- Protected against mismatching and maintenance-free
- Low profile with 4.4 mm pole spacing

#### Note:

All connectors for mounted installations (snap-in versions for lighting fixtures or devices, all types of PCB and distribution connectors) are factory-equipped with locking levers to ensure plugs and sockets are securely locked. Additional locking levers are only required for flying leads (plug /socket).

Subject to changes. Please also observe the further product documentation!

WAGO Kontakttechnik GmbH & Co. KG  
Hansastr. 27  
32423 Minden  
Phone: +49571 887-0 | Fax: +49571 887-169  
Email: [info.de@wago.com](mailto:info.de@wago.com) | Web: [www.wago.com](http://www.wago.com)

Do you have any questions about our products?  
We are always happy to take your call at +49 (571) 887-44222.

**Note on mismatching protection:**

All WINSTA<sup>®</sup> components are 100% protected against mismatching when:

- a.) plugging different numbers of poles
- b.) plugging while rotated 180
- c.) plugging while laterally staggered
- d.) plugging one pole

**Safety information 1:**

Application note for the U.S. market (USR): Some versions may also be used for current interruption in accordance with the UL certificate in select applications with currents below 5 A and voltages up to 600 V. For further information, please contact your local sales office.

**Data****Electrical data**

Note on Contact Resistance	approx. 1 mΩ of contact resistance approx. 0.25 mΩ contact transition plug/socket
----------------------------	---

**Ratings per IEC/EN 60664-1**

Ratings per	IEC/EN 60664-1
Nominal voltage (III/3)	250 V
Rated surge voltage (III/3)	4 kV
Rated current	16 A
Legend (ratings)	(III / 3) ≙ Overvoltage category III / Pollution degree 3

**Ratings per UL 1977**

Rated voltage UL 1977	600 V
Rated current UL 1977	14 A

**Connection data**

Pole No.	3
Total number of potentials	3
Ground function	with preceding ground contact

**Physical data**

Pin spacing	4.4 mm / 0.173 inch
Width	17.9 mm / 0.705 inch
Height	34 mm / 1.339 inch
Depth	53.9 mm / 2.122 inch

Subject to changes. Please also observe the further product documentation!

WAGO Kontakttechnik GmbH & Co. KG  
 Hansastr. 27  
 32423 Minden  
 Phone: +49571 887-0 | Fax: +49571 887-169  
 Email: [info.de@wago.com](mailto:info.de@wago.com) | Web: [www.wago.com](http://www.wago.com)

Do you have any questions about our products?  
 We are always happy to take your call at +49 (571) 887-44222.



## Mechanical data

Coding	A
Mating force of a plug-in connection	approx. 20 ... 70 N (depending on pole number)
Retention force of a plug-in connection	When locked: > 80 N
Unmating force of a plug-in connection	Unlocked: approx. 20 ... 70 N (depending on pole number)
Number of mating cycles	200, without resistive load 100, with resistive load $I_N = 16$ A, tested (1.5 mm <sup>2</sup> )
Distributor type	T-distribution connector
Marking	L N
Protection type	IP20
Note on protection type	IP40 when mated
Potential marking	L N
Application	General mains applications

## Plug-in connection

Contact type (pluggable connector)	Socket/plug
Mismating protection	Yes
Locking of plug-in connection	locking lever
Locking lever	yes

## Material Data

Color	black
Insulation material	Polyamide (PA66)
Contact material	Copper or copper alloy (surface-treated)
Fire load	0.158 MJ
Weight	8 g

## Environmental Requirements

Processing temperature	-5 ... +40 °C
Continuous operating temperature	-35 ... +85 °C
Note on continuous operating temperature	Insulating parts for temperatures $\leq 105$ °C

Subject to changes. Please also observe the further product documentation!

WAGO Kontakttechnik GmbH & Co. KG  
 Hansastr. 27  
 32423 Minden  
 Phone: +49571 887-0 | Fax: +49571 887-169  
 Email: [info.de@wago.com](mailto:info.de@wago.com) | Web: [www.wago.com](http://www.wago.com)

Do you have any questions about our products?  
 We are always happy to take your call at +49 (571) 887-44222.

## Commercial data



Product Group	20 (WINSTA)
Packaging type	BOX
Country of origin	DE
GTIN	4045454490485
Customs tariff number	85366990990

## Approvals / Certificates

### Country specific Approvals

Logo	Approval	Additional Approval Text	Certificate name
	CCA DEKRA Certification B.V.	EN 61535	71-11299
	CCA DEKRA Certification B.V.	IEC 61535	NL-64352

### Ship Approvals







Logo	Approval	Additional Approval Text	Certificate name
	ABS American Bureau of Shipping	Steel Vessel Rules	19- HG1869855- PDA
	DNV GL Det Norske Veritas, Germanischer Lloyd	-	TAE00001Z6
	LR Lloyds Register	EN 61535	08/20047 (E2)

### UL-Approvals

Logo	Approval	Additional Approval Text	Certificate name
	cURus Underwriters Laboratories Inc.	UL 1977	E45171

Subject to changes. Please also observe the further product documentation!

## Counterpart

	<b>Item no.890-103</b> Socket; with strain relief housing; 3-pole; Cod. A; 1,50 mm <sup>2</sup> ; black	<a href="http://www.wago.com/890-103">www.wago.com/890-103</a>
	<b>Item no.890-113</b> Plug; with strain relief housing; 3-pole; 1,50 mm <sup>2</sup> ; black	<a href="http://www.wago.com/890-113">www.wago.com/890-113</a>
	<b>Item no.890-203</b> Socket; 3-pole; Cod. A; 1,50 mm <sup>2</sup> ; black	<a href="http://www.wago.com/890-203">www.wago.com/890-203</a>
	<b>Item no.891-8993/105-101</b> pre-assembled connecting cable; Eca; Socket/open-ended; 3-pole; Cod. A; 1 m; 1,00 mm <sup>2</sup> ; black	<a href="http://www.wago.com/891-8993/105-101">www.wago.com/891-8993/105-101</a>
	<b>Item no.891-8993/005-101</b> pre-assembled interconnecting cable; Eca; Socket/plug; 3-pole; Cod. A; 1 m; 1,00 mm <sup>2</sup> ; black	<a href="http://www.wago.com/891-8993/005-101">www.wago.com/891-8993/005-101</a>
	<b>Item no.890-213</b> Plug; 3-pole; 1,50 mm <sup>2</sup> ; black	<a href="http://www.wago.com/890-213">www.wago.com/890-213</a>
	<b>Item no.891-8993/205-101</b> pre-assembled connecting cable; Eca; Plug/open-ended; 3-pole; Cod. A; 1 m; 1,00 mm <sup>2</sup> ; black	<a href="http://www.wago.com/891-8993/205-101">www.wago.com/891-8993/205-101</a>

## Downloads

### Documentation

#### Bid Text

890-606 doc - Datei	Nov 30, 2018	doc 23.0 kB	Download
890-606 GAEB X81 - Datei	Feb 19, 2019	xml 2.8 kB	Download

### CAD/CAE-Data

#### CAD data

2D/3D Models 890-606	URL	Download
----------------------	-----	----------

#### CAE data

EPLAN Data Portal 890-606	URL	Download
WSCAD Universe 890-606	URL	Download
ZUKEN Portal 890-606	URL	Download

Subject to changes. Please also observe the further product documentation!

## Installation Notes

### Installation

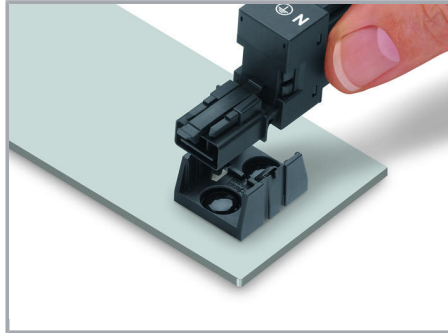

Secure the mounting plate via pins.

Subject to changes. Please also observe the further product documentation!